

Section 2

Electrical Components

Contents

Replacement Bulbs	2.2
Tail Lights	2.2
Strobe Lights	2.3
LED Strobe Lights	2.3
Flashing Lights	2.4
Dome Lights	2.4
Work/Spot Lights	2.5
Horns	2.6
Lift Truck Power Switch Keys	2.6
Grounding Straps	2.6
GE Plug Kits	2.6
Back-Up Alarms	2.7
Terminal Boards	2.7
Deutsch Connectors	2.8
Terminals	2.8
Switches	2.10
▪ Rocker and Toggle	2.10
▪ Key	2.10
▪ Keyless	2.10
▪ Snap Action	2.11
Wire and Cable	2.14
Fuses	2.15
Contactors	2.18

New Item:

LED Work Light with Turn Signal - p. 2.5



Replacement Bulbs

Part Number	Voltage	Vendor Number	Series
Dual Element			
078533-001	24	1638	Stockpickers, FC/FP, PE 4000
101957	36	SP5	Turrets, RC, SC
112480	12	1157	FC
Single Element			
083307	24	3011	SP36, SP42, SP48, TS
101365	24	1683	TSev100
105491	48	SP6	TSP
110578	12	93	Stockpickers
110581	12	1156	Stockpickers, FC/FP, TSev100
116364	12	1141	RR/RD 3000, RR/RD 5000
117993	36	SP1	FC/FP, FC 4000, SC 4000
117994	48	SP2	FC, FC 4000
118321	36	SP7	FC/FP
118322	48	SP8	FC/FP, RC 3000
Small with Short Base			
086042-001	14	386	RR, RD, RS, RR and RD Heated Cab, TS
087227	24	1819	PC, PE, PR, PW, RC, RR/RD/RS, RC, SC, SP36, SP42, SP48, W(HD), WB, WR
Sealed Beam (102 mm/4 in) Diameter			
340002-001	12	4411	
087195-001	24	4589	Reach Trucks, Stockpickers
102195	36	4350	Reach Trucks, Turrets, FC 4000, RC, RC 3000, SC, SC 4000
105619	48	4340	TSP
146957	12-48		LED sealed beam is a direct replacement for part numbers 340002-001, 087195-001, 102195 and 105619.
Small with Long Base			
105816	36	1822	TSP, TSev100, SP 3000
Long with Dual Contacts			
111382	12	211-2	FC
Bulb with Wire			
112481	12	H-3	FC
796059-005	24	H-3	ESR 4500
340075	48	H-3	
Strobe Halogen			
340009	12-80	5001	RR 5000
Bulb with Plug, Halogen			
125672	12	862	FC/FP, FC 4000, PE 4000
Flashtube - Strobe			
111782		400-537	TSP 6000



Tail Lights



Note: 1-year warranty on P.N. 117998 & 125318; 5-year warranty on P.N. 340014-XXX



Part Number	Description	Series	Voltage	Replacement Bulb
Bulb Light				
117998	Tail Light	FC/FP	48	117994
117998	Tail Light	FC/FP	36	117993
LED and Bulb Combination Light				
125318*	Combination - LED and bulb Tail Light	FC/FP, FC 4000	48	117994
125318*	Combination - LED and bulb Tail Light	FC/FP, FC 4000, SC 4000	36	117993
LED Light				
340014-001	LED Tail Light		12	
340014-002	LED Tail Light		24-36	
340014-003	LED Tail Light		48	

*LED not replaceable.

◀ Bulb Light Accessories

Replacement Lens

Part Number	Color
120717	Small Red
120718	Red Center
120719	Small Clear

340014-XXX Wiring Instructions

Wire Color	Function
White	Backup
White/Red	Tail
Red	Brake
Yellow	Turn
Black	Ground

Strobe Lights



Flat Mount Base

Part Number	Color	Assembly Height (in)	Mounting Hole to Mounting Hole (in)	Voltage
127651-001	Amber	5.25	3.40	12-80
127651-002	Red	5.25	3.40	12-80
127651-003	Blue	5.25	3.40	12-80

Note: 1-year warranty.

Kits (Flat Mount Base Only)

Part Number	Color	Voltage	Series
127509-001	Amber	12-80	SC 4000, FC 4000
127509-002	Red	12-80	SC 4000, FC 4000
127509-003	Blue	12-80	SC 4000, FC 4000

Note: Kits include weldment cover and lens blackout.



Conduit Mount Base

Part Number	Color	Assembly Height (in)	Diameter (in)	Voltage
112951-001	Amber	5.19	2.88	12-80
112951-002	Red	5.19	2.88	12-80
112951-003	Blue	5.19	2.88	12-80

Note: 1-year warranty.



Flat Mount Base - Low Profile

Part Number	Color	Assembly Height (in)	Mounting Hole to Mounting Hole (in)	Voltage
133186-001	Amber	4.48	4.382	12-80
133186-003	Blue	4.48	4.382	12-80
133186-004	Red	4.48	4.382	12-80

Note: 1-year warranty.

◀ 127651-XXX / 112951-XXX Accessories

Replacement Lens

Part Number	Color
113611	Amber
113612	Blue
113613	Red



Replacement Bulb

Part Number
340009

Accessory Guard

Part Number
118898



◀ 133186-XXX Accessories

Replacement Lens

Part Number	Color
137195-001	Red
137195-002	Amber
137195-003	Blue
137195-004	Green

Replacement Bulb

Part Number
111782

LED Strobe Lights



Flat Mount Base

Part Number	Color	Assembly Height (in)	Mounting Hole to Mounting Hole (in)	Voltage
138445-001	Amber	5.25	3.40	12-48
138445-002	Red	5.25	3.40	12-48
138445-003	Blue	5.25	3.40	12-48

Note: 5-year warranty.



Conduit Mount Base

Part Number	Color	Assembly Height (in)	Diameter (in)	Voltage
138445-004	Amber	5.25	2.81	12-48
138445-005	Red	5.25	2.81	12-48
138445-006	Blue	5.25	2.81	12-48

Note: 5-year warranty.

◀ 138445-XXX Accessories

Replacement Lens

Part Number	Color
340024-001	Amber
340024-002	Red
340024-003	Blue



Accessory Guard

Part Number
340006



Flashing Lights



Part Number	Description	Voltage	Series	Replacement Bulb
101458	2 wire filter	24	Stockpickers, PE 4000	078533-001
101755	2 wire filter	36	TS, TSP-72V	101957
102984	3 wire filter	36	RC, SC, TSev100, TSP-72V	101957
109711	3 wire filter	48	TSP	105491

Note: 1-year warranty.

▲ Kits

Part Number	Voltage	Series
101475-001	24	SP42
101475-002	24	SP36, SP48
101746	24	SP36, SP42, SP48, TSev100
102986	36	RC, SC

Note: 1-year warranty.

101746



102986



101475-001



▲ Accessories

Replacement Dome

Part Number	Color
085031	Amber
083308	Red



Accessory Guard

Part Number
085322



◀ 133186-002 Accessories

Replacement Lens

Part Number	Color
137195-001	Red
137195-002	Amber
137195-003	Blue
137195-004	Green

Replacement Bulb

Part Number
110581



Low Profile - Two Wire Filter

Part Number	Assembly Height (in)	Mounting Hole to		Voltage	Series
		Height (in)	Mounting Hole (in)		
133186-002	4.48	4.382	12-48	TSP 6000	

Note: 1-year warranty.

Dome Lights



Part Number	Voltage	Series	Replacement Bulb
109810	12	SP 3000, FC, TS, SP	110581

Note: 1-year warranty.

▲ Kits

Part Number	Description	Voltage	Series
117835-001	Assembly, 27" Batt. Comp.	12	FC
117835-002	Assembly, 33" Batt. Comp.	12	FC
117835-003	Assembly, 36" Batt. Comp.	12	FC

Note: 1-year warranty.



Part Number	Voltage	Series	Replacement Bulb
105043	48	TSP	105491
107392	36	TSP	101957

▲ Accessories

Replacement Lens

Part Number
104305

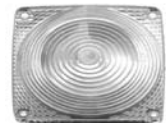

Part Number	V/C.P.	Series	Replacement Bulb
109811	12/15	SP 3000	110578
116319	12/21	RR 3000	116364

V/C.P. = Voltage/Candle Power

Note: 1-year warranty.

Work/Spot Lights

Work Lights

Part Number	Description	Voltage	Series	Replacement Bulb	Lens
145981	Front Work	12	C5	125672	Plastic
107712	Front Work	12	FC/FP	112481	Plastic
125674	Front Work	12	FC/FP	125672	Plastic
118129 (Bulb not included)	Front Work		FC/FP, RC 3000	110581 (80 volt) 118321 (36 volt) 118322 (48 volt)	Plastic
128653	Front/Rear Work	12	FC 4000, PE 4000	125672	Plastic
107713	Rear Work	12	FC/FP	112481	Plastic

Note: 1-year warranty.



◀ 125674 Accessories

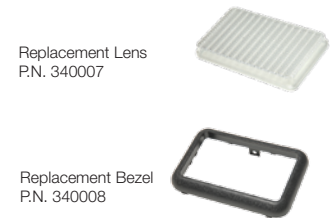

LED Work Lights

Part Number	Description	Voltage	Lens
340023-001	Bottom/Horizontal Mount	12-48	Plastic
340023-003	Bottom/Horizontal Mount with switch	12-48	Plastic
340023-004	Bottom/Horizontal Mount with switch and sensor	12-48	Plastic
340023-002	Side/Vertical Mount	12-48	Plastic
340023-005	Side/Vertical Mount with switch	12-48	Plastic
340023-006	Side/Vertical Mount with switch and sensor	12-48	Plastic

Note: 5-year warranty.

With Switch: on/off function only.

With Switch and Sensor: on/off function plus sensor will automatically dim the lamp to 25 percent of full power when in a bright environment. In dark environment will operate at full power.

Replacement Part: Wire assembly for all LED work lights is 340053.

Note: FC 4000 Series trucks require Mounting Bracket P.N. 145887.



LED Work Light with Turn Signal

Part Number	Description	Voltage	Lens
144053-002	Bottom/Vertical Mount White LEDs for visibility & amber for turn signal functionality	12-48	Plastic



Note: 5-year warranty.



Spot Lights

Part Number	Description	Voltage	Series	Replacement Bulb	Lens	Mounting Hardware Included
104296-001	Front/Rear	48	TSP	105619	Glass	x
104296-002	Front/Rear	36	RC, RC 3000, SC, SC 4000, Reach, TSev100, TSP	102195	Glass	x
104296-003	Front/Rear	24	Reach, SP	087195-001	Glass	x
104296-004	Spotlight	36	RC, RC3, SC, SC4, Reach, TSev100, TSP	102195	Glass	
104296-005	Spotlight	24	Reach, SP	087195-001	Glass	

Note: 1-year warranty.

LED Spot Lights

146958S	LED Spotlight	12-48		146957	Plastic	
145982-001	LED Spotlight	12-48		146957	Plastic	x

Note: 5-year warranty.

- Polycarbonate lens, can be used in food applications
- Last for life of the truck
- Lower cost of ownership than sealed beams

- Energy savings
- Bright light, more visibility
- One light, multiple voltages



Horns



Electronic Horn with Straight Bracket

Part Number	Voltage
332198	24, 36, 48



Electronic Horn with "L" Bracket

Part Number	Voltage
147631-001	24, 36, 48



Electronic Horn with "L" Bracket

Part Number	Voltage
143503*	12

*Note: Kit includes; horn, L-bracket, harness and kit instructions.



Mechanical Horns

Part Number	Voltage
078708-011	12
078708-002	24
078708-008	72



Suppressor

Part Number	Description
077732	For use with mechanical horns, 078708.
129579	Suppressor only needed in certain applications with new horn style, 132198-001 and 332198.

Lift Truck Power Switch Keys

Part Number	Type	Truck Series
107151-001	Molded	Walkies, Pallet, Tuggers
089216-001	Not Molded	
107151-002	Molded	Reach, Turret, Stockpickers, Counterbalance, PR 3000
107543-001	Not Molded	



107151-001



089216-001



107151-002



107543-001

Grounding Straps

Part Number	Length (in.)
102126-001	18.00
102126-002	10.50
102126-003	8.50
102126-004	5.75

Resistivity 100 OHM-CM



GE Plug Kits

Plug Kit (A) P.N. 108934



Plug Kit (B) P.N. 108935



Plug Kit (Y) P.N. 112528

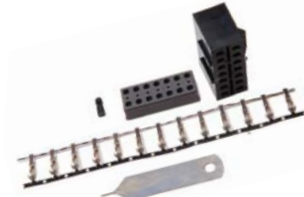

Plug Kit (Z) P.N. 108936



▲ Plug Kit Reference - Control Card

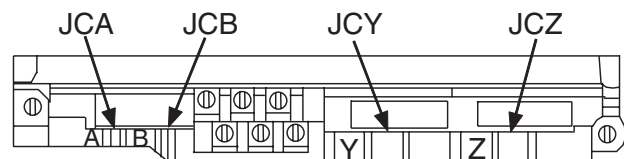

Back-Up Alarms



Part Number	Voltage	Decibel Level	Type
115565	12-48	97	Standard
129615	12-48	77-97	Smart
139068-001	12-24	82-102	Smart

▲ **Accessories:** Filter Block (P.N. 112533) for use with back-up alarms.



Filter Block Wiring Diagram

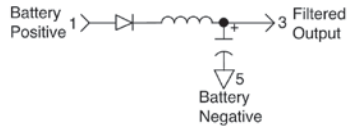

White Sound Back-Up Alarm



Part Number	Voltage	Decibel Level	Type
300113	36-80	97	Standard
300115	36-80	82	Standard
300116	12-24	77-97	Smart
300117	36-80	77-97	Smart

- Multi frequency broadband sound
- Shh - shh - shh sound compared to the beep - beep - beep of tonal alarms
- Tough, durable and guaranteed waterproof
- Lifetime warranty

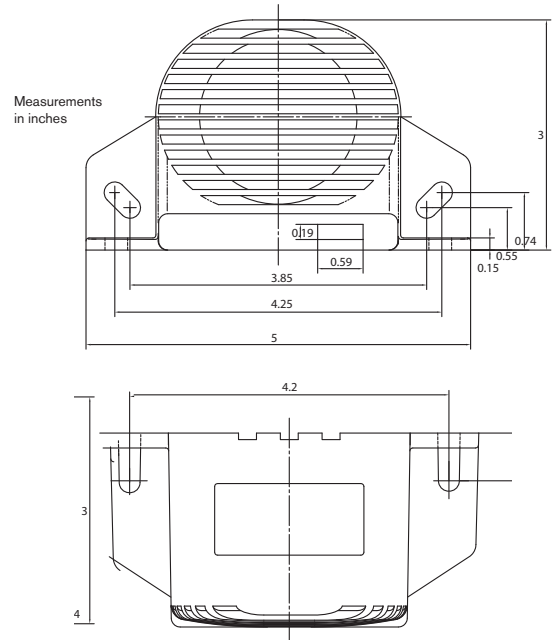

Terminal Boards

Terminals Rows x Count	A in / mm	B in / mm	Part Number
------------------------	-----------	-----------	-------------



See dimensional reference 1

2 x 6	2.63 / 67	2.91 / 74	079564-005
2 x 7	3.00 / 76	3.28 / 83	079564-010
2 x 8	3.38 / 86	3.66 / 93	079564-009
2 x 9	3.75 / 95	4.03 / 102	079564-004
2 x 11	4.50 / 114	4.78 / 121	079564-001
2 x 14	5.63 / 143	5.90 / 150	079564-013
2 x 16	6.38 / 162	6.66 / 169	079564-011
2 x 16	NA	NA	084674
2 x 19	7.50 / 191	7.78 / 198	079564-008
2 x 21	8.25 / 210	8.53 / 217	079564-002
2 x 30	11.63 / 295	11.90 / 302	079564-012



See dimensional reference 1

2 x 3	1.03 / 26	1.27 / 32	062014-001
2 x 4	1.30 / 33	1.52 / 39	062014-002

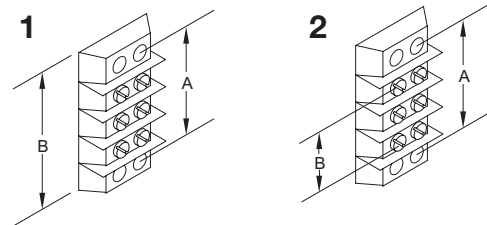

Terminals Rows x Count	A in / mm	B in / mm	Part Number
------------------------	-----------	-----------	-------------



See dimensional reference 2

1 X 10	4.81 / 122	4.25 / 108	079808*
14		NA	079809*

*Note: For EV100.

Deutsch Connectors

Deutsch Connector Kits



Part Number	Number of Circuits
130197-002	2
130197-003	3
130197-004	4
130197-006	6
130197-008	8
130197-012	12

Note: Kits include receptacle, plug, contacts, seals, inserts, and instructions on how to use extraction tool and crimping tool.

▲ Replacement Contacts

Part Number	Description	Quantity
130197-015	Pin, Nickle	25
130197-016	Socket, Nickle	25
130197-017	Pin, Gold	25
130197-018	Socket, Gold	25

Note: Used only on 130197-XXX.

Deutsch DTM Connector Kits



Part Number	Number of Circuits
131237-002	2
131237-003	3
131237-004	4
131237-006	6
131237-008	8
131237-012	12

Note: Kits include receptacle, plug, contacts, seals, inserts, and instructions on how to use extraction tool and crimping tool.

▲ Replacement Contacts

Part Number	Description	Quantity
131237-015	Pin, Nickle	25
131237-016	Socket, Nickle	25
131237-017	Pin, Gold	25
131237-018	Socket, Gold	25

Note: Used only on 131237-XXX.



Extraction Tool

Part Number - 062706

Used to remove Deutsch pin and socket contacts from DT and DTM connectors.



Crimping Tool

Part Number - 062737-002

For stripping insulation and crimping new Terminals on light gauge electrical wire for insertion into Deutsch DT and DTM connectors.

Terminals

Continued ▶

Adapting from Screw Terminals

Tab Size T x W	Stud Size	Part Number
0.13	0.25 (Tab)	062007-053
0.03 x 0.25	8	062007-027
0.03 x 0.25	8	062007-022
0.03 x 0.25	6	062007-030
0.03 x 0.25	8	062007-033
0.03 x 0.25	NA	062007-024
0.02 x 0.19	NA	062007-093



062007-022



062007-027



062007-030/033



062007-093



062007-024



062007-053



Receptacles, Crimp Snap-on

AWG Wire Size	Part Number
22-18	062007-066



Crimp Style Terminal

AWG Wire Size	Part Number
24-18	062007-082



Terminal Splice

AWG Wire Size	Part Number
16-14	062007-110
12-10	062007-107



Ring Tongue - Insulated

AWG Wire Size	Stud Size	Part Number
12	10	062007-029
12-10	8	062007-040
12-10	6	062007-056
12-10	5	062007-039
12-10	0.375	062007-102
12-10	0.25	062007-061
12-10	11 mm	062007-125
16-14	10	062007-070*
16-14	10	062007-013
16-14	8	062007-072
16-14	6	062007-073
16-14	4	062007-115
16-14	0.312	062007-071
16-14	0.25	062007-077
16-14	10.5 mm	062007-116
22-16	10	062007-032
22-16	8	062007-036
22-16	8	062007-104
22-16	6	062007-034
22-16	4	062007-019
22-16	2	062007-083
22-16	0.375	062007-041
22-16	0.312	062007-003
22-16	0.25	062007-047

*Note: Used in applications where two wires are used in one terminal.



Spring Tongue

AWG Wire Size	Stud Size	Part Number
14	8	062007-075
14	6	062007-074
22-16	10	062007-004
22-16	8	062007-005
22-16	6	062007-015
22-16	4	062007-084
26-22	6	062007-065



Butt Connectors

AWG Wire Size	Part Number
16-14	062007-103
22-16	062007-051



Connectors

Wire Range	Part Number	Manufacturer
18-10	062020-002	Molex
22-14	062020-001	Amp
22-14	062020-003	Molex



Male Snap-on Disconnects

AWG Wire Size	Tab Size T x W	Part Number
12-10	0.03 x 0.25	062007-060
16-14	0.02 x 0.25	062007-064
22-18	0.02 x 0.19	062007-111
22-18	0.03 x 0.25	062007-063



Female Snap-on Disconnects

AWG Wire Size	Tab Size T x W	Part Number
12-10	0.25	062007-058
14	0.25	062007-048
16-14	0.11 x 0.02	062007-086
16-14	0.03 x 0.11	062007-067
22-18	0.02 x 0.11	062007-112
22-18	0.02 x 0.19	062007-043
22-18	0.02 x 0.25	062007-021



Female Snap-on Disconnects

AWG Wire Size	Tab Size T x W	Part Number
12-10	0.03 x 0.25	062007-059
16-14	0.02 x 0.19	062007-080
16-14	0.03 x 0.19	062007-089
16-14	0.03 x 0.25	062007-076
16-14	0.03 x 0.25	062007-095
16-14	0.02 x 0.11	062007-121
16-14	0.187 x 0.02	062007-122
22-18	0.02 x 0.19	062007-092
22-18	0.03 x 0.19	062007-088
22-18	0.03 x 0.25	062007-050
22-18	0.02 x 0.11	062007-118
22-18	0.187 x 0.02	062007-124



Female Snap-on Disconnects

AWG Wire Size	Tab Size T x W	Part Number
22-18	0.187 x 0.032	062007-096
22-18	0.187 x 0.020	062007-098
22-18	0.03 x 0.25	062007-068
16-14	0.187 x 0.020	062007-099
16-14	0.02 x 0.25	062007-078



Female Snap-on Disconnects

AWG Wire Size	Tab Size T x W	Part Number
18	0.02 x 0.25	062007-054

Switches - Rocker and Toggle

OEM Key

Code OEM

AC = Allis Chalmers
BA = Baker Moto Truck

Code OEM

BR = Barrett
CL = Clark
TO = Caterpillar/
Towmotor

Code OEM

DW = Daewoo
HY = Hyster
SW = Intrupa

Code OEM

KO = Komatsu
LP = LPM
PM = Prime Mover

Code OEM

RA = Raymond
TY = Toyota
YT = Yale



Part Number - 117268

Turtle / rabbit symbols
Single pole / single throw

▼OEM

SW-2139	TY00591-45237-81	YT220015942
LP393-2604		



Part Number - 077633

Single pole / single throw
6A @ 125vdc
3A @ 250vdc

▼OEM

CL7004240	TO2I5054	YT220014497
HY800076231	TY00591-41984-81	YT800076231
SW-430	TY00591-60665-81	



Part Number - 062595-001

On-off-on
SPDT

▼OEM

HY800018665	TY00591-73979-81	YT800018665
LP393-9904	YT220041952	



Part Number - 062595-003

On (momentary)-off-on (momentary)
SPDT

▼OEM

SW-1794	LP393-9906	YT220042501
HY800018687	TY00591-73985-81	YT800018687



Part Number - 062595-002

On-none-off
SPST

▼OEM

SW-1793	LP393-9905	YT220042503
HY800018666	TY00591-73980-81	YT800018666



Part Number - 062595-004

On (momentary)-none-on
DPDT

▼OEM

SW-1795	TY00591-73981-81	SW-1832
HY800018667	YT800018667	LP393-7922
LP393-9907		

Switches - Key



Part Number - 078513

Includes: two keys

▼OEM

CL7004107	LP309-1678	TY00591-32282-81
HY3013966	TO2I6142	TY00591-56095-81
HY800019359		

Switches - Keyless



Part Number - 062623

Four Switch Positions
1. Accessories Only
2. Off Position
3. Accessories and Ignition
4. Ignition and Start (Spring Return)

▼OEM

HY800085364	LP309-2271	YT220025682
SW-1598	TY00591-14061-81	YT800085364
KO31-608		

Note: Reference OEM Key on page 2.10 for OEMs.



Part Number - 118901

SPNO
Polarity sensitive
10A @ 125 & 250vac
6A @ 30vdc

▼ OEM

SW-1283	LP393-8125	TY00591-57447-81
CL444113	TO2I5930	YT220003207
HY3012366	TY00591-05049-81	YT220003207
HY800076716	TY00591-32276-81	YT800076716



Part Number - 089362

Operating Force 6.5 oz min.
15A @ 125 and 250vac
0.6A @ 125vdc
0.3A @ 250vdc

▼ OEM

CL444113	LP393-8125	TY00591-57447-81
HY3012366	TO2I5930	YT220003207
HY800076716	TY00591-05049-81	YT220030452
SW-1283	TY00591-32276-81	YT800076716



Part Number - 073363

▼ OEM

CL7004066	TY00591-32235-81	TY00591-60634-81
SW-1207		



Part Number - 082605

15A @ 30vdc

▼ OEM

BALF021874	SW-2154	YT220016301
HY800076416	LP393-2533	YT800076416



Part Number - 062714

▼ OEM

SW-1831	LP393-7921
---------	------------



Part Number - 147014

General Purpose
Single Throw
Single Pole
Normally Open
2A 48VDC

▼ OEM

CL7004060	SW-1199	TY00591-60635-81
HY3012350	TO2I6161	YT220014587
HY800019130	TY00591-32227-81	YT800019130



Part Number - 073375

▼ OEM

CL443898	SW-1227	TY00591-57409-81
CL946483	LP393-2500	YT220003926
CL7004078	TO2I6162	YT800076075
HY3015165	TY00591-04651-81	
HY800076075	TY00591-32247-81	



Part Number - 113352

▼ OEM

SW-1897	113352	LP393-2798
---------	--------	------------



Part Number - 082813

▼ OEM

CL7004134	TY00591-41846-81	YT220014503
HY800058813	TY00591-60694-81	YT800058813
SW-1376	TY00591-70619-81	



Part Number - 088294

▼ OEM

CL7004239	SW-429	TY00591-60723-81
HY800076690	TY00591-32345-81	YT800076690



Part Number - 077656

▼ OEM

BA130091	SW-32	YT6202871
BA985383	SW-33	YT220023939
BA985838	SW-342	YT220037742
BA986600	SW-344	YT220043325
BA997030	LP393-2160	YT220051993
BA177MJH1	LP393-2172	YT500205100
BABZ2RQ13A2	RA1-150-324	YT600287100
BABZ2RQ1A2	RA590-023	YT620287100
BAPAL32	RA590-058	YT620287101
BAPAL-32A	RADS226498	YT2200519-93
CL991179	TO0972328	YT5002051-00
HY1371673	TO1009550	YT6202871-00
HY2307677	TY00591-32333-81	YT6202871-01
HY3007411	TY00591-51917-81	YT62028710A
HY3008403	TY4516581100-71	

Note: Reference OEM Key on page 2.10 for OEMs.



Part Number - 101589

Operating Force 15 oz max
15A @ 125vac and 250vac

▼ OEM

CL7004122	TO2I6135	TY00591-60538-81
HY800075101	TY00591-04181-81	YT220016504
SW-1359	TY00591-32291-81	YT800075101



Part Number - 079133

▼ OEM

CL7004092	LP393-8216	TY00591-60672-81
HY800076274	TO2I6134	YT220015887
SW-1275	TY00591-32271-81	YT800076274



Part Number - 062683

Operating force 75 grams max
Release force 10 grams min
SPDT with gold contacts

▼ OEM

HY800018685	LP393-2325	YT800018685
SW-1643	TY00591-73984-81	



Part Number - 086221

▼ OEM

CL7004131	LP393-7910	TY00591-70648-81
HY800058861	TY00591-41845-81	YT220014951
SW-1373	TY00591-60714-81	YT800058861



Part Number - 072007

▼ OEM

CL7004058	TY00591-41779-81	YT220021468
SW-1197	TY00591-60632-81	



Part Number - 078879

▼ OEM

CL7004059	TO2I5965	YT220002205
HY3017812	TY00591-32226-81	
SW-1198	TY00591-60668-81	



Part Number - 077133-001

Blue
10A @ 28vdc

▼ OEM

CL7004054	TO2I6159	YT220013133
HY3013964	TY00591-04742-81	YT800076207
HY800076207	TY00591-32220-81	
SW-1191	TY00591-52537-81	



Part Number - 077133-002

Black
SPDT
10A @ 28vdc

▼ OEM

CL7004055	TO2I6155	TY00591-60663-81
HY800076208	TY00591-04743-81	YT220003691
SW-1192	TY00591-32221-81	



Part Number - 075198

Single pole - double throw
Operating force 8 oz
Release force 4 oz

▼ OEM

AC4932316	PM201199	YT220024965
AC74932316	PMQU-161A8598G1	YT220051040
BA992567	RA1150-034	YT500742800
BRA27350-6	RA1150-322	YT721260301
CL996101	RA921-000/224	YT721260303
HY1194848	RADS226131	YT800076158
HY3008482	TO0972065	YT800076269
HY3012351	TO1009548	YT0136151CB
HY800076158	TY00591-04789-81	YT0523328-00
HY800076269	TY00591-32318-81	YT136151-CB
HYA-3720	TY00591-51929-81	YT5007428-00
SW-151CB	TY00591-51930-81	YT549-GS-92-A
KO7870-30-7120	YT015804300	YT549-GS-92-B
KO7870-30-7210	YT015804400	YT6136151CB
KO78703-07210	YT015804500	YT7212603-01
LP393-4219	YT052332800	YT7212603-03
LP393-4230	YT220023578	



Part Number - 078927

▼ OEM

AC4932316	PMQU-161A8598G1	YT052332800
AC74932316	RA1150-034	YT220023578
BA992567	RA1-150-322	YT220024965
BR27350-006	RA921-000-224	YT220051040
BRA27350-6	RADS226131	YT500742800
BRA-27350-6	TO0972065	YT721260301
CL996101	TO972065	YT721260303
HY1194848	TO1009548	YT800076158
HY3008482	TY00591-04789-81	YT800076269
HY3012351	TY00591-32318-81	YT0136151CB
HY800076158	TY00591-51929-81	YT0523328-00
HY800076269	TY00591-51930-81	YT5007428-00
HYA-3720	YT158044	YT549-GS-92-A
SW-151CB	YT158045	YT549-GS-92-B
KO7870-30-7120	YT523328	YT6136151CB
KO78703-07210	YT5007428	YT7212603-01
LP393-4219	YT015804300	YT7212603-03
LP393-4230	YT015804400	
PM201199	YT015804500	

Note: Reference OEM Key on page 2.10 for OEMs.



Part Number - 076314

▼ OEM

AC4905826	HY239018	YT129349018
AC4913480	HY244502	YT129349048
AC74905826	HY279015	YT129991042
AC74913480	HY281874	YT129991044
BA119A4259P1	HY1196167	YT220050004
BA119A4259P3	HY6201865	YT220050200
BA177MAA1	HY800076184	YT440028865
BA177MAF1	HYA244502	YT500879800
BA177MBV1	HYA2445020	YT511872801
BA177MDP1	HYA2445028	YT511872802
BA177MDT1	HYA244502R	YT649222101
BA177MFA1	SW-1012	YT722960100
BA177MGN1	SW-1091	YT741091000
BA177MGP1	SW-91C	YT800076184
BA9007A02	SW-91E	YT0105967-00
BA9007A04	JN1403300	YT01361510E
BAA02	LP393-4310	YT074109100C
BACR115B2	PM1177	YT07410910A
BAGEC48	PM1770	YT07410910B
BASD245	PM201177	YT07410910C
BR27409-001	PM201770	YT0741091-0C
BR27410-004	PMQU-119A4259P3	YT07410910D
BR4694-000	PMQZ-9007AO2	YT079338600E
BRA27409-1	PMU-119A4259P3	YT0793436NB
BRA27410-4	PMZ-9007AO2	YT1291610-19
BRA27410-8	RA590-029	YT1293490-18
BRA4694	RA590-037	YT1293490-48
BRP02296-27	RA590-059	YT1299910-42
BRP02297-27	RA590-066	YT1299910-44
BRT29-1223	RA590-073-07	YT2200500-04
CL421612	TO0333627	YT2200502-00
CL655111	TY00591-32351-81	YT2242-C-13G1
CL850466	TY00591-51933-81	YT5008798-00
CL861042	YT010596700	YT5118728-01
CL868164	YT016047200	YT5118728-02
CL871260	YT016049100	YT5770-E-1001
CL871620	YT019646800	YT577-GK-11
CL882304	YT023527600	YT577-GK-16
CL882308	YT051773600	YT61361510E
CL891946	YT051773700	YT6136151-0E
CL990589	YT052091000	YT6492221-01
CL991973	YT054106900	YT7229601-00
CL995123	YT059330100	YT7410910-00
CL1689403	YT059349900	YT741091-0B
CL3453937	YT061361500	YT741091-C
CL3480484	YT063558700	YT793386-E
HY0188709	YT070076100	YT741091-0B
HY188709	YT074109100	YT741091-C
HY0238340	YT074109103	YT793386-E
HY238340	YT074109180	
HY239016	YT129161019	



Part Number - 077481

▼ OEM

CL778570	HYA121224	TY00591-04755-81
HY121224	SW-1029	TY00591-41762-81
HY1198464	LP393-8115	TY00591-57445-81
HY3007247	LP393-9153	



Part Number - 087373

Operating force 6.5 oz max
Release force 1.5 oz min. 10A @ 30vdc

▼ OEM

AC4778736	DW908450	TY00591-32194-81
AC4795031	HY2311178	TY00591-32359-81
AC4798071	HY3016151	TY00591-51916-81
AC74778736	SW-1039	TY00591-51928-81
AC74795031	SW-151FA	TY00591-60541-81
AC74798071	SW-1859	YT5148261
BA106944	SW-983	YT5152921
BA106994	KO34B-55-23610	YT220002082
BA709677	KO34B-55-23610	YT220015035
BA985402	KO34B-57-23610	YT220015420
BA992717	KO3BA-57-23610	YT220023943
BA177MBH1	LP393-2142	YT220051964
BABXRW22A2	LP393-4172	YT514826100
BABZ2RM22A2	PM49965-00	YT515292100
BABZ2RW22A2	PMA49965	YT01361510F
BACB6	TO015949	YT01361510N
BACB61	TO0060302	YT0136151FA
BACB6-1	TO0300905	YT2200519-64
BACB6DASH1	TO0319033	YT5148261-00
BR28841-330	TO0336130	YT5152921-00
BR29000465-000	TO0659968	YT61361510F
BRT29-465	TO0908450	YT61361510N
BRT-29-465	TO0972189	YT6136151FA
CL906619	TO912463	YT6136151-0F
CL7004041	TOMCF00311	YT61361510N
CL7004253	TOMCF00313	YT6136151FA



Part Number - 123437

Operating force 8.5 ox max,
Release force 1.5 oz min

▼ OEM

INSW-1595	LP393-2532	YT800108047
HY800108047	YT220035914	



Part Number - 062715

Operating force 175 grams
Release force 19 grams

▼ OEM

SW-1789	LP393-1939	TOSE000006
SW-1830	LP393-7920	



Part Number - 079267

▼ OEM

HY800076277	TY00591-41801-81	YT220015460
SW-1274	TY00591-60673-81	YT800076277
TY00591-04793-81		

Switches - Snap Action

Note: Reference OEM Key on page 2.10 for OEMs.



Part Number - 109759

▼ OEM

SW-1377	TY00591-32296-81	YT220015021
CL7004135	TY00591-60557-81	YT800058911
HY800058911	TY00591-70676-81	



Part Number - 109758

▼ OEM

SW-1348	TY00591-32290-81	TY00591-60556-81
HY3013965	TY00591-52550-81	YT220003692
TY00591-05093-81		

Wire and Cable

Power Cable

Part Number	Gauge	Ordering Instructions
084568-010	6	Order quantity is length in feet - black UL
384569-010	4	10 ft - black UL
384569-050	4	50 ft - black UL
384569-105	4	100 ft - red, not UL rated
384569-250	4	250 ft - black UL
384575-050	4	50 ft - red UL
384575-100	4	100 ft - red UL
344570-050	2	50 ft - black UL (same as 084570-100)
344570-100	2	100 ft - black UL (same as 084570-100)
344570-500	2	500 ft - black UL (same as 084570-100)
384576-050	2	50 ft - red UL
384576-100	2	100 ft - red UL
344571-050	1	50 ft - black UL (same as 084571-100)
344571-100	1	100 ft - black UL (same as 084571-100)
384571-050-02	1	50 ft - red UL
384571-100-02	1	100 ft - red UL
384572-050	1/0	50 ft - black UL
384572-100	1/0	100 ft - black UL
384574-050	1/0	50 ft - red UL
384574-100	1/0	100 ft - red UL
384573-013	2/0	100 ft - red, not UL rated
384573-014	2/0	100 ft - orange not UL rated
384573-100	2/0	100 ft - black UL
384573-250	2/0	250 ft - black UL
384577-100	4/0	100 ft - black UL
384578-100	4/0	100 ft - red not UL rated

Control Cable

Part Number	Conductor	Length/Feet
119203-015	12	250
119203-016	12	500
389203-011-01	9	100
389203-001-50	8	50
389203-001-01	8	100
119203-002	8	250
119203-003	8	500
389203-004-50	5	50
389203-004-01	5	100
119203-005	5	250
119203-006	5	500
387374-025	4	25
387374-100	4	100
387374-750	4	750
389203-007-50	3	50
389203-007-01	3	100
119203-008	3	250
119203-009	3	500
389495-050	2	50
389495-100	2	100
389495-250	2	250
389495-001	2	1000

Control Wire

Part Number	Gauge	Wire Color	Length ft/m
086563-002	18	Black	100/30.5
086564-002	18	Brown	100/30.5
086565-002	18	Red	100/30.5
086566-002	18	Orange	100/30.5
086567-002	18	Yellow	100/30.5
086568-002	18	Green	100/30.5
086569-002	18	Blue	100/30.5
086570-002	18	Violet	100/30.5
086571-002	18	Gray	100/30.5
086572-002	18	White	100/30.5
086573-002	18	Red Stripe/White	100/30.5
086574-002	18	Green Stripe/White	100/30.5

Aircraft Cable, Nylon Coated Galvanized

Part Number	Length/Feet
384755-050	50
384755-100	100
074755-083	250
074755-084	500

Aircraft Cable, Galvanized Steel

Part Number	Length/Feet
383189-050	50
383189-100	100
083189-128	250
083189-129	500

Small DIM



Part Number	Max Voltage	Amps	Ferraz/ Gould	Littelfuse	Bussman
340032-002	250Vac	2	GDC2	312-2	AGC2
340032-R06	250Vac	6	GDC-R-6	312-6	AGC-R-6
090132	250Vac	10	GDC10	312-10	AGC10
340032-015	32Vac	15	GGC15	312-15	AGC15
340032-020	32Vac	20	GGC20	312-20	AGC20
340032-030	32Vac	30	GGC30	312-30	AGC30

Small DIM



Part Number	Max Voltage	Amps	Ferraz/ Gould	Littelfuse	Bussman
340044-002	250Vac	2	GSC2	239002	GMD-2-R

Small DIM



Part Number	Max Voltage	Amps	Ferraz/ Gould	Littelfuse	Bussman
340039-025	250Vac	1/4	GDL1-1/4	313250	MDL-1/4
100645		1	GDL7	313001	MDL-1
340039-002	250Vac	2	GDL2	313002	MDL-2
340039-015	32Vac	15	GDL15	313015	MDL-15
100988	32Vac	20	GDL20	313020	MDL-20

Small DIM



Part Number	Max Voltage	Amps	Ferraz/ Gould	Littelfuse	Bussman
340049-001	250Vac	1	GGM1	235001	GMA-1-R
094744	250Vac	3	GGM3	235003	GMA-3-R

Medium Time-Delay



Part Number	Max Voltage	Amps	Ferraz/ Gould	Littelfuse	Bussman
340045-001	250Vac	1	GSC1	235-1	GMC-1-R
340045-005	125Vac	5	GSC5	235-5	GMC-5-R

Fast Acting



Part Number	Max Voltage	Amps	Ferraz/ Gould	Littelfuse	Bussman
078450	250	2			C2

MIN TD



Part Number	Max Voltage	Amps	Ferraz/ Gould	Littelfuse	Bussman
127038-001	250Vac (or Less)	1/4	GDG1/4	218.250	GDC250mA
340034-001	250Vac (or Less)	1	GDG1	218.001	GDC1
340034-016	250Vac (or Less)	1.6	GDG1-6/10	218.016	GDC1.6
340034-003	250Vac (or Less)	3.15	GDG3-15/100	218.3.15	
340034-005	250Vac (or Less)	5	GDG5	218.005	GDC5

Semiconductor



Part Number	Max Voltage	Amps	Ferraz/ Gould	Littelfuse	Bussman
340033-012	250Vac/125Vdc	12	250VFA6X32	322-12	GBB12

Auto



Part Number	Max Voltage	Amps	Ferraz/ Gould	Littelfuse	Bussman
071902-001	32Vac	7	307007	SFE9	SFE9
071902-002	32Vac	14	307014	SFE14	SFE14

Fast Acting



Part Number	Amp	Max Voltage	Type	Littelfuse	...	in
084190	1/4	250	AGX	361.250	AGX1/4	1.0 0.25

Medium-Acting Radial Leaded Ceramic



Part Number	Amp	Max Voltage	A mm	B mm	Littelfuse
052071-001	0.63	80	20	5	2010630
052071-002	2	100	20	5	234002
052071-003	10	100	20	5	234010

Fast Acting



Part Number	Max Voltage	Amp	Ferraz/ Gould	Littelfuse	Bussman	A in	B in
094362-005	250Vac/125Vdc	3/8	GAB3/8	314.375	ABC3/8	1.25	0.25
094362-004	250Vac/125Vdc	3/4	GAB3/4	314.75	ABC3/4	1.25	0.25
094362-003	250Vac/125Vdc	2	GAB2	314.002	ABC2	1.25	0.25
094362-008	250Vac/125Vdc	3	GAB3	314.003	ABC3	1.25	0.25
094362-001	250Vac/125Vdc	4	GAB4	314.004	ABC4	1.25	0.25
094362-006	250Vac/125Vdc	5	GAB5	314.005	ABC5	1.25	0.25
094362-012	250Vac/125Vdc	6	GAB6	314.006	ABC6	1.25	0.25
094362-013	250Vac/125Vdc	8	GAB8	314.008	ABC8	1.25	0.25
094362-010	250Vac/125Vdc	10	GAB10	314.010	ABC10	1.25	0.25
094362-002	250Vac/125Vdc	15	GAB15	314.015	ABC15	1.25	0.25
094362-007	125Vac/125Vdc	30	GAB30	314.030	ABC30	1.25	0.25
094362-009			Shorting Bar		NCC	1.25	0.25

Fast Acting

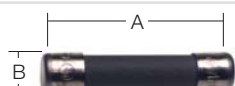

Part Number	Max Voltage	Amp	Ferraz/ Gould	Littelfuse	Bussman	A in	B in
094362-011	250Vac (or Less)	1	GSA1	326001	MDA1	1.25	0.25
094362-020	250Vac (or Less)	20	GSA20	326020	MDA20	1.25	0.25

Fast Acting General Purpose



Part Number	Max Voltage	Amps	Ferraz/ Gould	Littelfuse	Bussman
340038-005	600	5	SBS005	KLQ005	KTQ5

One Time General Purpose Fuse



Part Number	Max Voltage	Amps	Ferraz/ Gould	Littelfuse	Bussman
090125	250Vac	30	OT-30	NLN-30	NON-30
340050-060	250 Vac	60	OT-60	NLN-60	NON-60

Low Voltage, Time Delay, Supplementary



Part Number	Max Voltage	Amps	Ferraz/ Gould	Littelfuse	Bussman
340042-004	250Vac or less	4	FNM-4	FLM-4	FNM-4
340042-005	250Vac or less	5	FNM-5	FLM-5	FNM-5
340042-006	250Vac or less	6	FNM-6	FLM-6	FNM-6
340042-012	125Vac or less	12	FNM-12	FLM-12	FNM-12

Low Voltage, Time-Delay, Branch Circuit, Rejection Type



Part Number	Max Voltage	Amps	Ferraz/ Gould	Littelfuse	Bussman
340041-025	600Vac or less	0.25	FNQ-R-.25	FLQ-R-.25	FNQ-R-.25
340041-050	600Vac or less	0.5	FNQ-R-.5	FLQ-R-.5	FNQ-R-.5
340041-001	600Vac or less	1	FNQ-R-1	FLQ-R-1	FNQ-R-1
340041-035	600Vac or less	3.5	FNQ-R-3.5	FLQ-R-3.5	FNQ-R-3.5

Low Voltage, Fast Acting, Branch Circuit, Rejection Type



Part Number	Max Voltage	Amps	Ferraz/ Gould	Littelfuse	Bussman
340037-005	600Vac or less	1	ATMR1	KLK-R-1	KTK-R-1
340037-004	600Vac or less	4	ATMR4	KLK-R-4	KTK-R-4

Low-Peak CC TD



Part Number	Max Voltage	Amps	Ferraz/ Gould	Littelfuse	Bussman
340030-003	150Vdc-300Vdc-600Vac	3	ATDR3	KLMR3	LP-CC-3
340030-004	150Vdc-300Vdc-600Vac	4	ATDR4	KLMR4	LP-CC-4
340030-006	150Vdc-300Vdc-600Vac	6	ATDR6	KLMR6	LP-CC-6
340030-008	150Vdc-300Vdc-600Vac	8	ATDR8	KLMR8	LP-CC-8
340030-010	150Vdc-300Vdc-600Vac	10	ATDR10	KLMR10	LP-CC-10
340030-015	150Vdc-300Vdc-600Vac	15	ATDR15	KLMR15	LP-CC-15
340030-020	150Vdc-300Vdc-600Vac	20	ATDR20	KLMR20	LP-CC-20
340030-030	150Vdc-300Vdc-600Vac	30	ATDR30	KLMR30	LP-CC-30

Low Peak, Dual Element, Time Delay



Part Number	Max Voltage	Amps	Ferraz/ Gould	Littelfuse	Bussman
340031-045	600Vac/300Vdc	4.5	AJT4.5	JTD4.5	LPJ-4.5SP
340031-010	600Vac/300Vdc	10	AJT10	JTD10	LPJ-10SP
340031-012	600Vac/300Vdc	12	AJT12	JTD12	LPJ-12SP
340031-015	600Vac/300Vdc	15	AJT15	JTD15	LPJ-15SP
340031-020	600Vac/300Vdc	20	AJT20	JTD20	LPJ-20SP
340031-025	600Vac/300Vdc	25	AJT25	JTD25	LPJ-25SP
340031-030	600Vac/300Vdc	30	AJT30	JTD30	LPJ-30SP
340031-035	600Vac/300Vdc	35	AJT35	JTD35	LPJ-35SP
340031-040	600Vac/300Vdc	40	AJT40	JTD40	LPJ-40SP
340031-044	600Vac/300Vdc	45	AJT45	JTD45	LPJ-45SP
340031-050	600Vac/300Vdc	50	AJT50	JTD50	LPJ-50SP
340031-060	600Vac/300Vdc	60	AJT60	JTD60	LPJ-60SP
340031-070	600Vac/300Vdc	70	AJT70	JTD70	LPJ-70SP
340031-080	600Vac/300Vdc	80	AJT80	JTD80	LPJ-80SP
340031-090	600Vac/300Vdc	90	AJT90	JTD90	LPJ-90SP
340031-100	600Vac/300Vdc	100	AJT100	JTD100	LPJ-100SP
340031-125	600Vac/300Vdc	125	AJT125	JTD125	LPJ-125SP
340031-150	600Vac/300Vdc	150	AJT150	JTD150	LPJ-150SP
340031-175	600Vac/300Vdc	175	AJT175	JTD175	LPJ-175SP
340031-225	600Vac/300Vdc	225	AJT225	JTD225	LPJ-225SP
340031-400	600Vac/300Vdc	400	AJT400	JTD400	LPJ-400SP

RK5 TD



Part Number	Max Voltage	Amps	Ferraz/ Gould	Littelfuse	Bussman
340018-006	600	6	TRS6R	FLSR-R6	FRS-R6
340018-007	600	7	TRS7R	FLSR-R7	FRS-R7
340018-008	600	8	TRS8R	FLSR-R8	FRS-R8
340018-009	600	9	TRS9R	FLSR-R9	FRS-R9
340018-010	600	10	TRS10R	FLSR-R10	FRS-R10
340018-012	600	12	TRS12R	FLSR-R12	FRS-R12
340018-015	600	15	TRS15R	FLSR-R15	FRS-R15
340018-020	600	20	TRS20R	FLSR-R20	FRS-R20
340018-025	600	25	TRS25R	FLSR-R25	FRS-R25
340018-030	600	30	TRS30R	FLSR-R30	FRS-R30
340018-035	600	35	TRS35R	FLSR-R35	FRS-R35
340018-040	600	40	TRS40R	FLSR-R40	FRS-R40
340018-045	600	45	TRS45R	FLSR-R45	FRS-R45
340018-050	600	50	TRS50R	FLSR-R50	FRS-R50
340018-060	600	60	TRS60R	FLSR-R60	FRS-R60

Class H



Part Number	Max Voltage	Amps	Ferraz/ Gould	Littelfuse	Bussman
340015-010	600	10	OTS10	NLS10	NOS10
340015-015	600	15	OTS15	NLS15	NOS15
340015-020	600	20	OTS20	NLS20	NOS20
340015-025	600	25	OTS25	NLS25	NOS25
340015-030	600	30	OTS30	NLS30	NOS30
340015-035	600	35	OTS35	NLS35	NOS35
340015-040	600	40	OTS40	NLS40	NOS40
340015-045	600	45	OTS45	NLS45	NOS45
340015-050	600	50	OTS50	NLS50	NOS50

Stud MTD



Part Number	Max Voltage	Amps	Ferraz/ Gould	Littelfuse	Bussman
132083-001	125	50	CNN50	CNN50	ANN50
340016-060	125	60	CNN60	CNN60	ANN60
340016-100	125	100	CNN100	CNN100	ANN100
340016-125	125	125	CNN125	CNN125	ANN125
340016-150	125	150	CNN150	CNN150	ANN150
340016-175	125	175	CNN175	CNN175	ANN175
340016-200	125	200	CNN200	CNN200	ANN200
340016-225	125	225	CNN225	CNN225	ANN225
340016-250	125	250	CNN250	CNN250	ANN250
132083-005	125	300	CNN300	CNN300	ANN300
340016-325	125	325	CNN325	CNN325	ANN325
340016-350	125	350	CNN350	CNN350	ANN350
132083-002	125	400	CNN400	CNN400	ANN400
132083-003	125	500	CNN500	CNN500	ANN500
132083-006	125	700	CNN700	CNN700	ANN700
132083-004	125	800	CNN800	CNN800	ANN800
340047-040	80	40	CNL40	CNL40	ANL40
340047-080	80	80	CNL80	CNL80	ANL80
340047-200	80	200	CNL200	CNL200	ANL200
340047-250	80	250	CNL250	CNL250	ANL250
340047-350	80	350	CNL350	CNL350	ANL350
340047-500	80	500	CNL500	CNL500	ANL500
340047-600	80	600	CNL600	CNL600	ANL600
340047-675	80	675	CNL675	CNL675	ANL675

V-Fuse, Enclosed



Part Number	Max Voltage	Amps
814995-002	24	50

Fuse Strip w/ Housing for Battery Powered Vehicles - Fast Acting



Part Number	Max Voltage	Amps	Bussman	Littelfuse	A mm	B mm
802816-006	80	50		157.5917.5501	82	9
802816-003	80	100		157.5701.6101	60	11
802816-007	80	100		157.5917.6101	60	9
802816-001	80	125		157.5701.6121	60	11
802816-005	80	125		157.5917.6121	60	9
802816-009	80	150		157.5917.615	60	9
802816-002	80	160		157.5701.6161	60	11
802816-004	80	200		157.5701.6201	60	11
790586	80	250			60	11
806720-001	80	425		157.5701.642	60	11

T-Tron Fast Acting



Part Number	Max Voltage	Amps	Ferraz/ Gould	Littelfuse	Bussman
340046-001	300Vac or less	70	A3T70	JLLN70	JJN70
340046-080	300VAC or less	80	A3T80	JLLN80	JJN80
340046-002	300Vac or less	100	A3T100	JLLN100	JJN100
340046-003	300Vac or less	150	A3T150	JLLN150	JJN150
340046-300	300VAC or less	300	A3T300	JLLN300	JJN300
340046-004	300Vac or less	350	A3T350	JLLN350	JJN350
340046-400	300VAC or less	400	A3T400	JLLN400	JJN400
340046-005	300Vac or less	450	A3T450	JLLN450	JJN450
340046-006	300Vac or less	600	A3T600	JLLN600	JJN600

High Speed Fuse



Part Number	Max Voltage	Amps	Ferraz/ Gould	Littelfuse	Bussman
340017-100	150	100	A15QS-100-4	L15S100	FWA-100B
340017-150	150	150	A15QS-150-4	L15S150	FWA-150B
340017-200	150	200	A15QS-200-4	L15S200	FWA-200B
340017-250	150	250	A15QS-250-4	L15S250	FWA-250B
091344	150	300	A15QS-300-4	L15S300	FWA-300B
340017-350	150	350	A15QS-350-4	L15S350	FWA-350B
340017-400	150	400	A15QS-400-4	L15S400	FWA-400B
340017-500	150	500	A15QS-500-4	L15S500	FWA-500A

Fast Acting Automotive Blade



Part Number	Max Voltage	Amps	Ferraz/ Gould	Littelfuse	Bussman	Type
805751-002	32	2	AF2	164.6185.4202	ATC2	Gray
805751-006	32	4	AF4	166.7000.440	ATC4	Pink
806703-002	80	5		166.7000.450		Light Brown
805751-001	32	10	AF10	164.6185.5102	ATC10	Red
062765-001	32	15	AF15	164.6185.5152	ATC15	Blue
806703-001	80	15		166.7000.515		Light Blue

J-Case, Slo-Blo Automotive Cartridge



Part Number	Max Voltage	Amps	Type	Littelfuse
062902-003	32	40	Green	995-40

Time Delay Fuse



Part Number	Max Voltage	Amps	Ferraz/ Gould	Littelfuse	Bussman
076924-017	125	15		CCK15	ACK15
076924-018	125	20		CCK20	ACK20
076924-012	125	30		CCK30	ACK30
076924-011	125	40		CCK40	ACK40
076924-001	125	60		CCK60	ACK60
076924-003	125	100			ALS100
076924-004	125	120			ACK120A
076924-005	125	140			ACK140
076924-014	125	160			ACK160
076924-006	125	175			ACK175
076924-016	125	175			ALS175
076924-002	125	200			ALS200
076924-007	125	200			ACK200
076924-015	125	225			ALS225
076924-009	125	250			ALS250
076924-020	125	250			ACK250
076924-010	125	300			ALS300
076924-013	125	300			ACK300
076924-021	125	300	ALS300		
076924-022	125	300	ACK300		
076924-008	125	400			ALS400
340051-500	125	500	ALS500		

Capacitor Type- Fast Acting



Part Number	Max Voltage	Amps	Ferraz/ Gould	Littelfuse	Bussman
340036-100	600	100	A60C100-121TL		KGJ-E-100

In-Line Non-Rejecting



Part Number	Max Voltage	Amps	Ferraz/ Gould	Littelfuse	Bussman
340035-003	300Vac (or Less)	3	SLR3	LGR3	GLR-3
340035-010	300Vac (or Less)	10	SLR10	LGR10	GLR-10

Super-Lag Renewable

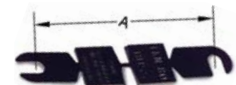

Part Number	Max Voltage	Amps	Ferraz/Gould	Littelfuse	Bussman	A in
081614	80	250	RL80	LKN80	LKN80	2.56
076789	125	250	RL125	LKN125	LKN125	2.625
074282	200	250	RL200	LKN200	LKN200	2.625
071597	250	250	RL250	LKN250	LKN250	2.625

Automotive ATM Mini Blade



Part Number	Max Voltage	Amps	Ferraz/ Gould	Littelfuse	Bussman	Type
062897-001	32	5	AFZ5	997005	ATM5	Tan
062897-003	32	10	AFZ10	997010	ATM10	Red
062897-004	32	15	AFZ15	997015	ATM15	Blue
062897-005	32	20	AFZ20	997020	ATM20	Yellow
062897-006	32	2	AFZ2	997002	ATM2	Gray

Contactors



Style A



Style B



Style C



Style D



Style E



Style F

OEM Key

AC = Allis Chalmers
BR = Barrett

CL = Clark
HY = Hyster
JG = Jungheinrich

KO = Komatsu
LP = LPM
MT = Mitsubishi

NI = Nissan
PM = Prime Mover
RA = Raymond

TO = Caterpillar/Towmotor
TY = Toyota
YT = Yale

Part Number	Style	Voltage	Amps	OEM		
116794-002	A	24	150	HY800075381 LP375-1943	LP375-7809	TY00591-44166-81
116794-005	A	24	150	HY800075380 LP375-1948	LP375-6125	TY00591-44171-81
110613-001	B	24	150	LP375-1945	LP375-3047	TY00591-44168-81
110613-002	B	24				
110613-003	B	24	150	HY800064625 LP375-1946	LP375-3048 TY00591-44169-81	TY00591-72323-81 YT520293803
110613-005	B	36/48	150	HY800075255 LP375-1947	LP375-3049	TY00591-44170-81
110613-007	B	36				
117853-001	B	24	250	HY80000537	LP375-1073	
120975	B	24	100	LP375-1951 LP375-3056	TY00591-44150-81	YT220043708
104483	C	24	150	AC4967344 AC4967616 AC4967618 AC78730634 BR39187-001 CL4308934 CL7001657 CL912089 CL912363 CL913903 HY0388227 HY2014096 HY0388227 HY800082018 HY800082021	JG14480230 JG14520932 KO200098 KO24205-01 27692-00 KO3BA-47-A4170 KO3WB-47-A1530 LP375-7100-GE MT9712402600 MT97C5701100 PM7692-00 PM200098 PM27692 RA1-105-204 TO9712402600	TO97C5701100 TY00591-04280-81 TY00591-23819-81 TY00591-30734-81 TY00591-51694-81 TY00591-30736-81 YT501227249 YT504227249 YT505075506 YT220023787 YT220073460 YT800082018 YT800082021
111634	C	24	100	CL914626 HY800082008 LP375-7117-GE NICK914626	PM201348 PMQU-IC2800M254C4B TY00591-23809-81	TY0059-136799-81 TY0059-151676-81 TY00591-63750-81
093575	D	24		CL7001616 LP375-6121 LP375-6121-GE	PM201354 PMQU-IC0M611AA13A TO216138	TY00591-30691-81 TY00591-51691-81 YT220003286
093576	D	24		CL7001619 LP375-6006	TY00591-30695-81	YT220003287
093574	D	24		LP375-6129 PM201356	PMQU-IC0M611AC13A TY00591-30692-81	YT220003285
112329	D			CL7001619 LP375-6006	TY00591-30695-81	YT220003287
112329-002	D					
116962	D			HY800075391	LP375-7833	
112328	D			HY800076791	LP375-6008	
112327	D			HY800020423	LP375-6007	
104140	E	24	150	BR28841-654 BR39186-001 CL912091 KO3WB-47-A1540 KOGA150AH124XN LP375-7101-GE	PM200100 PM26673-02 PM27693-02 TO97124-02800 TY00591-30732-81	TY00591-51695-81 YT220015003 YT220023784 YT5042242-80 YT5050755-07
106109-001	E	36	150	AC8730877 CL912094 HY3055351 HY388016 LP375-7118-GE	NICK912094 PM202169 PM27693-04 YT220023785 TY00591-23814-81	TY00591-36801-81 TY00591-57039-81 TY00591-60549-81
106109-003	E	36-48	150	CL915631 HY1300938 HY800082014 LP375-7113-GE	MT97122-06600 TO9712206600 TY00591-23815-81	TY00591-30733-81 TY00591-57037-81 YT220026251
118396	F	24	150	HY800075421 LP375-1949	LP375-3018	TY00591-44144-81